

COMPAC[®]

MANUFACTURER SINCE 1946



**60% MORE
POWER***

COMPAC SPRING COMPRESSOR CSC+

Safe and effective solutions
for strong springs on electric
cars, SUVs, vans, etc.

See page 33 for more information

* CSC+ compared with CSC.



You
Tube

Keyword:
Compac CSC+

CATALOGUE NO 14



TABLE OF CONTENTS



How Compac creates value

4-7



Low height jack 2 ton



Extremely low chassis jack 2 ton



Jack for vans, SUVs and campers 3 ton



10



High capacity jacks 4 - 15 ton



11



High lift jacks 1,4 - 2 ton



12



High lift jacks 3 - 10 ton



13



Air hydraulic trolley jacks 1,6 - 10 ton



14+18



Air hydraulic telescopic jacks



16-17



Hydraulic body repair kits



19



Axle stands 2 - 12 ton



20



Wheel lifter for cars, vans and SUVs



21



Wheel dolly and wheel lifter for trucks and buses



22-23



Wheel lifter for agricultural and earth moving machinery



24-25



Workshop cranes



26-27



**Universal transmission jacks
Accessories for transmission jacks**



28-29



Telescopic transmission jack for cars, vans and SUVs



30



Telescopic transmission jack for trucks and buses



31



Spring compressors



32-33



**Foot operated
workshop presses 16 - 30 ton**



34



**Hand operated
workshop presses 20 - 30 ton**



35



**Foot operated
workshop presses 40 - 50 ton**



36



**Hand operated
workshop presses 40 - 100 ton**



37



**Electro-hydraulic
workshop presses 40 - 100 ton**



38-39



Bottle jacks 3 - 50 ton



40

HOW COMPAC CREATES VALUE **Lifting is serious business – We know!**

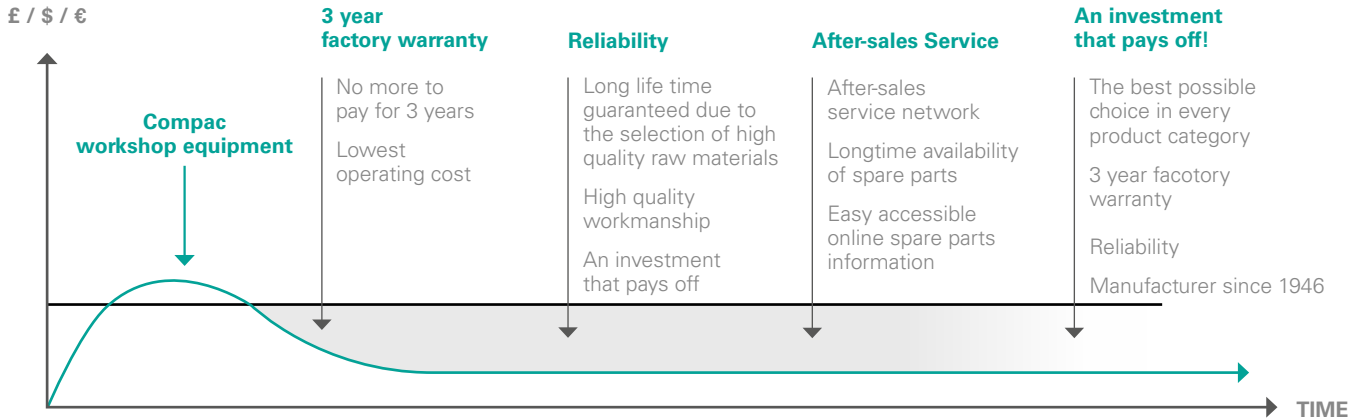

KNOW-HOW IS THE DIFFERENCE

FACTORY WARRANTY

Compac has set a benchmark in the industry by being the first manufacturer to offer a full 3 year warranty.





HISTORY

Four dedicated Danes established Compac in 1946. Their vision was to build superior hydraulic jacks. Our vision is still the same after more than 70 years in business and we are proud to continue in our efforts to strengthen our reputation for superior quality, which we have built up over the years.

KNOW-HOW IS THE DIFFERENCE



MANUFACTURER SINCE 1946

Compac has been manufacturing high quality hydraulic products since 1946. The aim of the experienced engineering staff at Compac is to ensure excellent quality with the key objective of creating satisfied customers.





LONGTIME AVAILABILITY OF SPARE PARTS

Spare parts and wear parts for Compac products are easy to identify and access. Information about spare parts for all Compac products is easily available on www.compac.dk or by using Compac's App.



ONLINE INFORMATION

Easy access to all spare parts information. Find the right solution for the job. YouTube films for clear understanding of the user benefits. Operation instructions and trouble shooting guides with step-by-step guides to help you solve any functional problems on-site.





EXCELLENT RAW MATERIALS

Compac's hydraulic components are manufactured in-house using high quality materials. Important raw materials like the special hydraulic tubes, seals, valve blocks, etc. are sourced from high quality raw material suppliers only. There are no compromises concerning the quality of the critical raw materials used in Compac's hydraulic systems.

UNIQUE QUALITY SYSTEM

Compac operates a unique quality system that is inspired by the Japanese quality approach. The stringent quality system combines the quality mind-set and personal responsibility of everyone involved in the manufacturing process.





LOW HEIGHT JACK 2 TON CARS



Special adapters

for lifting points on electric and hybrid cars.



See page 15 for all the various solutions.



Ideal for lifting points along side panels.



Ergonomically designed handle for operator comfort.

"Lift-and-turn" lowering system prevents unintentional lowering.

Heavy duty fully welded structure in high quality steel.

Max. height 500 mm.

Quick approach foot pedal.

Protective cylinder jacket to prevent intrusion of dirt and welding splatter.

Min. height 80 mm.

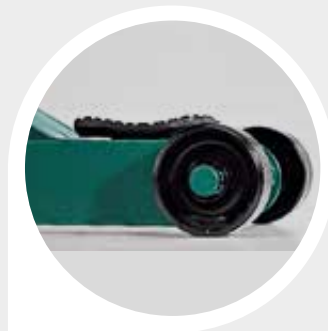

Low entry height.

Built-in safety lowering control valve for safe lowering even under maximum load.

Built-in pressure relief valve prevents overloading.

Noise reducing nylon wheels.

ACCESSORIES



060260
CSL LED light for jacks.



1002LF
Rubber pad protects the lifting point.



003068
Saddle for extra height or accessing lifting points situated behind skirts, etc. (+ 40 mm)



2T-C HRW
2T-C Mounted with hard rubber wheels. (Factory mounted)



2T-C BOGIE PU
Noiseless polyurethane rollers and wheels. (Factory mounted)

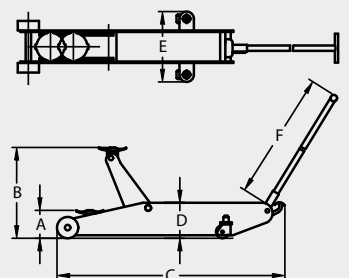

Model	Max (ton)	A (mm)	B (mm)	C (mm)	D (mm)	E (mm)	F (mm)	Kg
2T-C	2	80	500	730	160	380	925	36



EXTREMELY LOW CHASSIS JACK 2 TON CARS



YouTube

Keyword:
Compac 2T-77



Special adapters
for lifting points on
electric and hybrid cars.

See page 15 for all the
various solutions.



Extremely low chassis improves access
under low vehicles.



Long reach chassis improves access
to lifting points deep under vehicles.



Low entry height.

ACCESSORIES



060260
CSL LED
light for
jacks.



001077
Rubber pad protects
the lifting point.



003068
Saddle for extra height
or accessing lifting points
situated behind skirts, etc.
(+ 40 mm)



2T-77 HRW
2T-77 Mounted with
hard rubber wheels.
(Factory mounted)



2T-77 BOGIE PU
Noiseless polyurethane
rollers and wheels.
(Factory mounted)

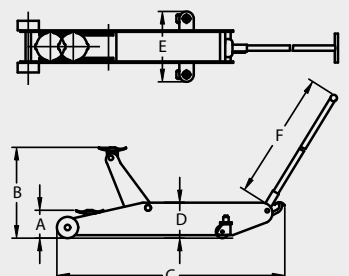

Model	Max (ton)	A (mm)	B (mm)	C (mm)	D (mm)	E (mm)	F (mm)	Kg
2T-77	2	77	480	950	126	380	925	42



3 TON JACK VANS, SUVS AND CAMPERS



Long reach chassis improves access to lifting points deep under most vehicles.

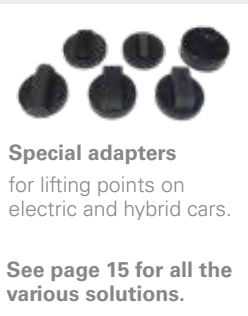

ACCESSORIES

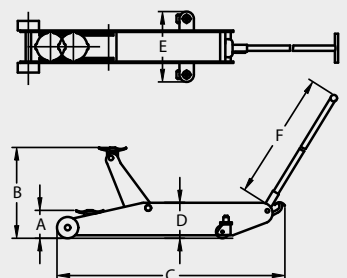

Model	Max (ton)	A (mm)	B (mm)	C (mm)	D (mm)	E (mm)	F (mm)	Kg
3T-C	3	115	500	1015	170	380	925	43



HIGH CAPACITY JACKS 4 - 15 TON TRUCKS AND BUSES



Long reach chassis improves access to lifting points deep under trucks.

10T-C with accessory 060200



YouTube

Keyword:
Compac 10T-C

Ergonomically designed handle for operator comfort.



Quick approach foot pedal.



Min. height 165 mm.



Built-in safety lowering control valve for safe lowering even under maximum load.

Large diameter swivel wheels for easy handling.



Min. height 130 mm.

ACCESSORY



060200
Air rubber tyres fitted on point of balance enhance manoeuvrability of large jacks. Will flatten under load.

Model	Max (ton)	A (mm)	B (mm)	C (mm)	D (mm)	E (mm)	F (mm)	Kg
4T-C	4	130	545	1270	200	465	1045	74
5T-C	5	145	560	1270	200	465	1045	75
6T-C	6	155	570	1395	210	470	1045	97
10T-C	10	165	580	1410	225	435	1045	110
12T-C	12	170	670	1700	280	470	1045	148
15T-C	15	200	600	1790	325	475	1045	169

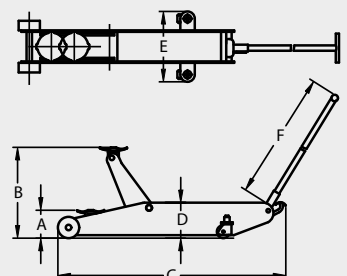



HIGH LIFT JACKS 1,4 - 2 TON CARS



Max. height 715 mm.

1,4T-HC 77

Quick approach foot pedal.

Ultra low entry height only 77 mm.

Special adapters

for lifting points on electric and hybrid cars.



See page 15 for all the various solutions.

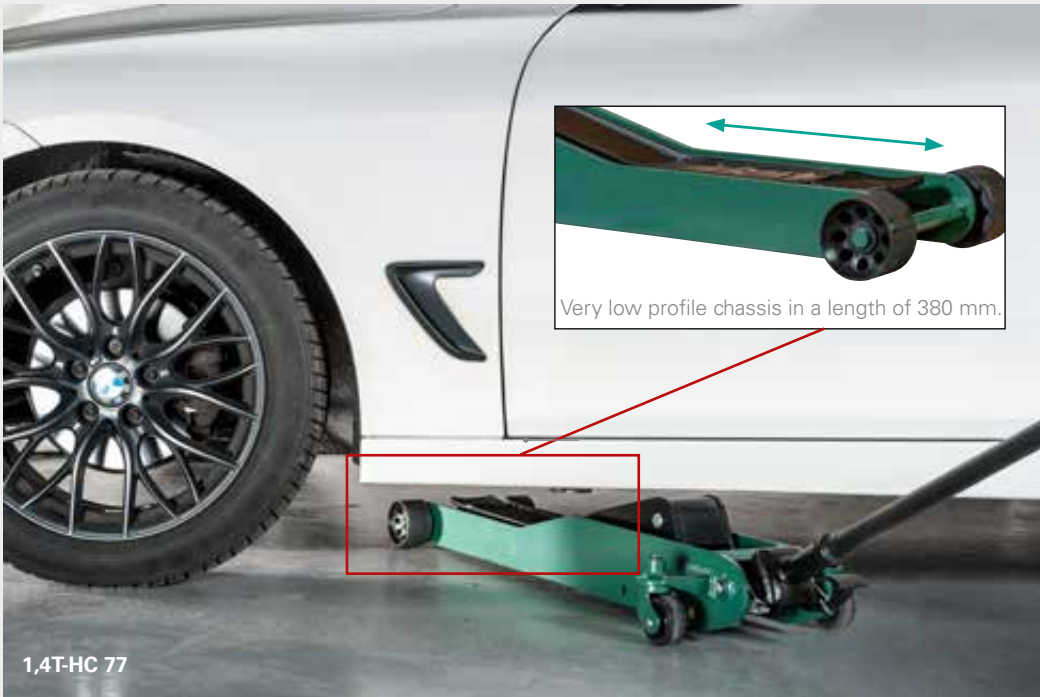

Very low profile chasis in a length of 380 mm.

1,4T-HC 77

Long reach profile improves access to lifting points deep under most vehicles.

Model	Max (ton)	A (mm)	B (mm)	C (mm)	D (mm)	E (mm)	F (mm)	Kg
1,4T-HC 77	1,4	77	715	1050	190	380	925	52
2T-HC	2	98	735	1035	200	380	1045	56

ACCESSORIES

060260
CSL LED
light for
jacks.



Model	Nr.
1,4T-HC 77	001077
2T-HC	1002LF

Rubber pad protects the lifting point.



1,4T-HC 77 BOGIE PU
2T-HC BOGIE PU
Jack mounted with polyurethane rollers. (Factory mounted)



1,4T-HC 77 HRW
2T-HC HRW
Jack mounted with hard rubber wheels. (Factory mounted)

Built-in safety lowering control valve for safe lowering even under maximum load.

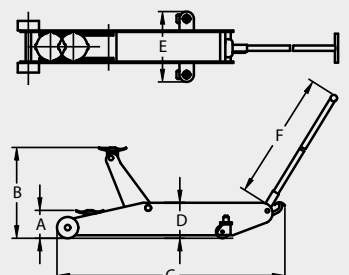



HIGH LIFT JACKS 3 - 10 TON

AGRICULTURAL MACHINERY



ACCESSORY



060200
Air rubber tyres fitted on point of balance enhance manoeuvrability of large jacks. Will flatten under load.

8T-HC with accessory 060200

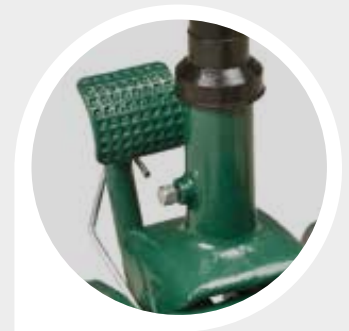

Model	Max (ton)	A (mm)	B (mm)	C (mm)	D (mm)	E (mm)	F (mm)	Kg
3T-HC	3	130	860	1620	210	460	1045	91
6T-HC	6	180	960	1830	350	475	1045	180
8T-HC	8	180	960	1830	350	475	1045	185
10T-HC	10	210	710	1700	290	475	1045	148

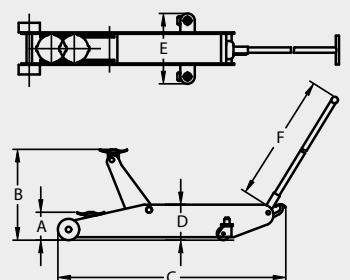



EXTREMELY LOW AIR HYDRAULIC TROLLEY JACK 1,6 TON CARS



Long reach chassis improves access to lifting points deep under vehicles.

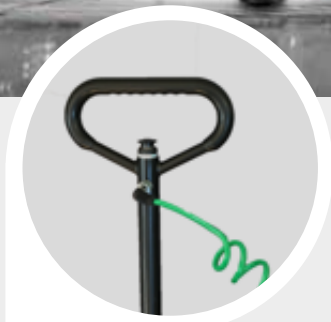

Fast and silent air pump. Less than 70 dB.



Maximum lifting height 480 mm.



Extremely low and long reach chassis.

Ultra low entry height only 77 mm.



You Tube

Keyword: Compac A1,6T-77



Extremely low chassis improves access under low vehicles.



Low entry height.

ACCESSORIES



060260
CSL LED light for jacks.



001077
Rubber pad protects the lifting point.



003068
Saddle for extra height or accessing lifting points situated behind skirts, etc. (+ 40 mm)



A1,6T-77 HRW
A1,6T-77 mounted with hard rubber wheels. (Factory mounted)



A1,6T-77 Bogie PU
A1,6T-77 mounted with noiseless polyurethane rollers and wheels.

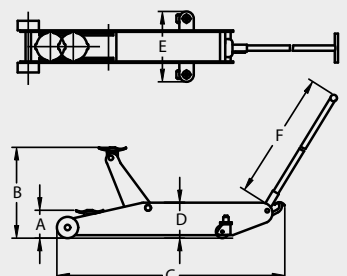

Model	Max (ton)	A (mm)	B (mm)	C (mm)	D (mm)	E (mm)	F (mm)	Kg
A1,6T-77	1,6	77	480	950	126	380	925	44



SPECIAL ADAPTERS FOR LIFTING POINTS ON ELECTRIC AND HYBRID VEHICLES



SPECIAL ADAPTERS THAT FIT THE ORIGINAL LIFTING POINTS



These adapters fit the special lifting points on most of the new car models from the above mentioned vehicle manufactures.

The adapters can be placed on a standard saddle on Compac trolley jack.

Important: Please note that there are 2 types of adapters for Tesla. Always make sure that the correct type of adapter is used.



AIR HYDRAULIC JACKS TRUCKS AND BUSES



A5816-C

LOW TELESCOPIC JACK WITH SHORT CHASSIS AND EXTREMELY LOW TELESCOPIC JACK

- Built-in safety control valve for safe lowering even under maximum load.
- Built-in pressure relief valve prevents overloading.
- Spring loaded lowering system with dead man release.



Keyword:
Compac A4020-C



Keyword:
Compac A5816-C

STANDARD

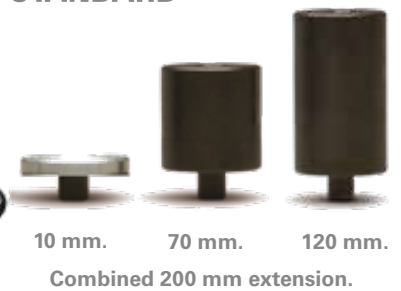

ACCESSORIES



0Y1600
Extensions set.
3 x 20 mm. 1 x 10 mm.



0Y2618
"V" saddle for
lifting on axles and
round lifting points.



0Y1407
Saddle Ø140 mm.

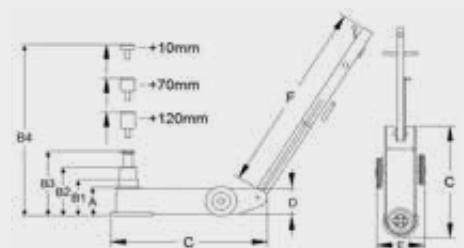

Model	Max (ton)	A (mm)	B1 (mm)	B2 (mm)	B3 (mm)	B4 (mm)	C (mm)	D (mm)	E (mm)	F (mm)	Kg
A3216-C	32/16	150	220	300	-	500	495	168	310	1230	46
A4020-C	40/20	150	220	300	-	500	495	168	310	1230	46
A5816-C	58/32/16	120	165	210	255	455	665	130	305	1360	57



AIR HYDRAULIC JACKS

TRUCKS AND AGRICULTURAL MACHINERY



A28-HC

EXTRA HIGH AIR HYDRAULIC JACK AND TELESCOPIC JACK WITH EXTRA HIGH LIFTING CAPACITY



A28-HC

A4422-C

Model	Max (ton)	A (mm)	B1 (mm)	B2 (mm)	B3 (mm)	B4 (mm)	C (mm)	D (mm)	E (mm)	F (mm)	Kg
A28-HC	28	350	580	-	-	780	735	160	280	1230	64
A4422-C	44/22	220	341	467	-	667	525	168	300	1230	53
A5830-C	58/30	220	330	450	-	650	1050	150	350	1360	80

STANDARD

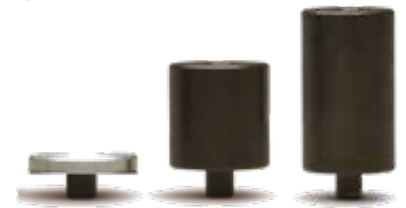

10 mm. 70 mm. 120 mm.

Combined 200 mm extension.

ACCESSORIES



0Y1600
Extensions set.
3 x 20 mm. 1 x 10 mm.



0Y2618
"V" saddle for lifting on axles and round lifting points.



0Y1407
Saddle Ø140 mm.

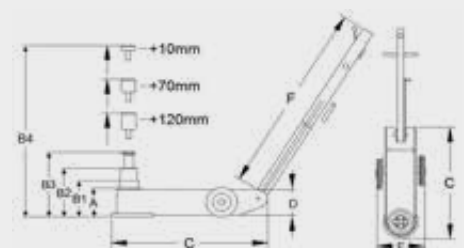



AIR HYDRAULIC TROLLEY JACK 10 TON AGRICULTURAL MACHINERY



HYBRID COMPAC® 10-TON AIR HYDRAULIC TROLLEY JACK



YouTube Keyword:
Compac
A10T-HC



Model	Max (ton)	A (mm)	B (mm)	C (mm)	D (mm)	E (mm)	F (mm)	Kg
A10T-HC	10	150*	780**	1380	225	390	1200	113

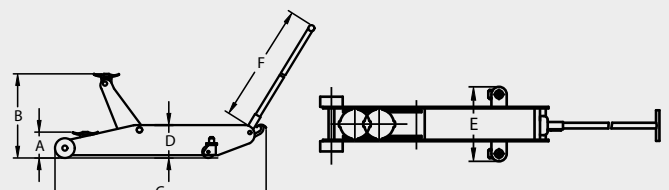

* Without standard extension / ** With standard extension



HYDRAULIC BODY REPAIR KITS

CARS, TRUCKS AND AGRICULTURAL MACHINERY



Max. capacity 4 ton.



17
CRK 4
Weight: 19 kg.

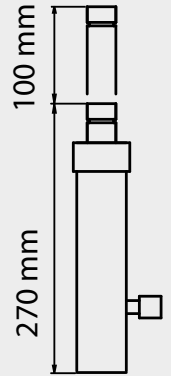

Max. capacity 10 ton.



Ideal for lifting, spreading and pushing applications. Hydraulic body repair kits are ideal for various applications in automotive body repair workshops, industrial applications, etc.

Long stroke.

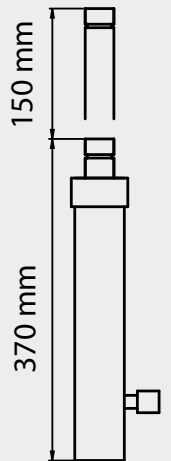

17
CRK 10
Weight: 36 kg.

	CRK 4	CRK 10
1	Quick-lock tube, 400 mm.	Quick-lock tube, 475 mm.
2	Quick-lock tube, 300 mm.	Quick-lock tube, 350 mm.
3	Quick-lock tube, 200 mm.	Quick-lock tube, 250 mm.
4	Quick-lock tube, 100 mm.	Quick-lock tube, 125 mm.
5	"V" head.	"V" head.
6	Threaded toe adapter.	Threaded toe adapter.
7	Angle head.	Angle head.
8	Wedge head.	Wedge head.
9	Base.	Base.
10	Saddle.	Saddle.
11	Flexible rubber head.	Flexible rubber head.
12	Connector.	Connector.
13	Spreader. (Max 500 kg.)	Spreader. (Max 500 kg.)
14	Cylinder.	Cylinder.
15	Flexible hose, 1800 mm.	Flexible hose, 1800 mm.
16	4 ton hydraulic power unit.	10 ton hydraulic power unit.
17	Box.	Box with wheels.



WARNING: The capacity of the hydraulic system exceeds the maximum of the spreader and other adapters. Please see maximum capacity per component in the instruction manual.



AXLE STANDS 2 - 12 TON



ROBUST CONSTRUCTION FOR MAXIMUM STABILITY AND SAFETY

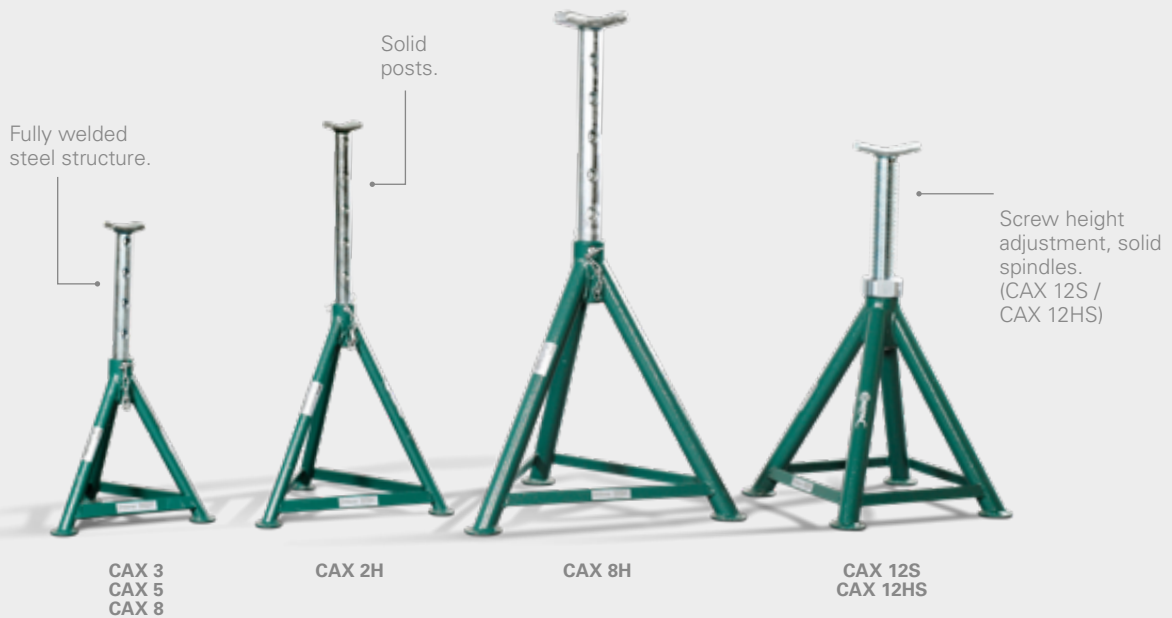

Keyword:
Compac
CAX range

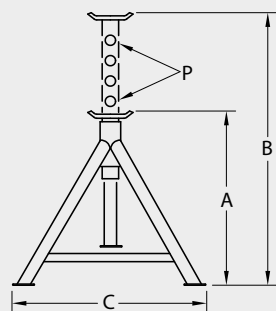

Model	Max (ton)	A (mm)	B (mm)	C (mm)	P	Kg
CAX 2H	2	505	755	491	5	6,6
CAX 3	3	346	510	325	5	4,7
CAX 5	5	406	567	355	5	7,2
CAX 8	8	424	633	403	5	11,5
CAX 8H	8	605	870	575	6	15
CAX 12S	12	345	495	230	Spindel	11,6
CAX 12HS	12	505	740	395	Spindel	14,4



WHEEL LIFTER CARS, VANS AND SUVs

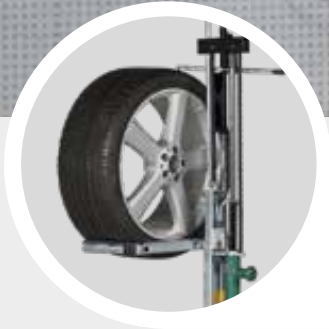

Easy access to wheel bolts. The wheel is positioned away from the main piston.



YouTube

Keyword: Compac WD 60

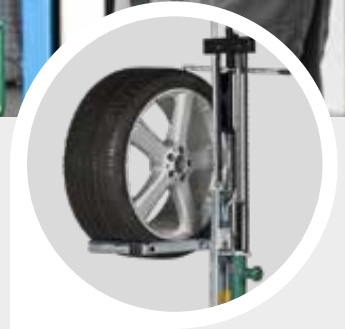

Capacity: 60 kg. (Outside diameter max. 820 mm.)



Rollers with ball bearings for easy rotation and positioning.



Effortless foot operated lifting.

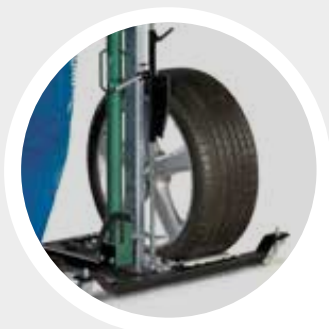

No heavy, manual lifting. The wheel lifter lifts the wheels straight from the floor.

WD 60

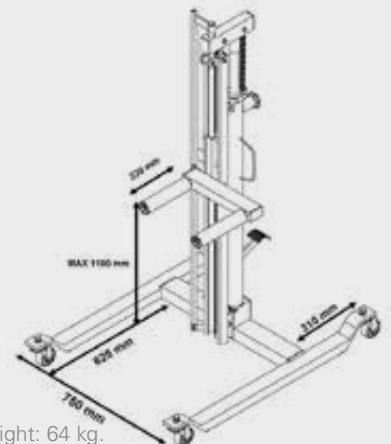

Weight: 64 kg.



WHEEL HANDLING TRUCKS AND BUSES



EASY AND SAFE MOUNTING, DEMOUNTING AND HANDLING OF HEAVY WHEELS FOR TRUCKS AND BUSES.

Extra support wheels for
easy and safe maneuvering
even when fully loaded.

Capacity
250 kg.

Rollers with ball bearings
for easy rotation and
positioning of wheels
onto hubs.



WD MOBILE

Weight: 14 kg.

Ergonomical handle
makes the wheel dolly
easily controllable by
just one mechanic.

Capable of handling wheels
up to size 445/65 - 22,5"



The rollers have three positions
each side for different wheels
sizes.

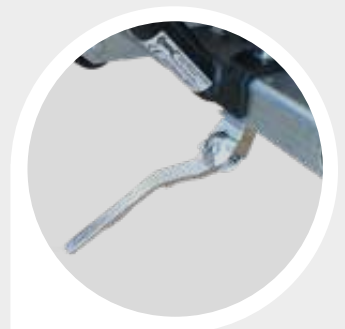

Spring loaded support for fast
and easy storing without load.



WHEEL LIFTER TRUCKS AND BUSES



WD 500
Capacity 500 kg.



Easy maneuvering even when fully loaded.

Rollers fitted with ball bearings easy for rotation and positioning of wheels.

Weight: 101 kg.



100% foot operated.
Even under maximum load.



Keyword:
Compac WD 500



Sliding arms. Enables handling of wheels with diameter from Ø 260 mm - 1320 mm.

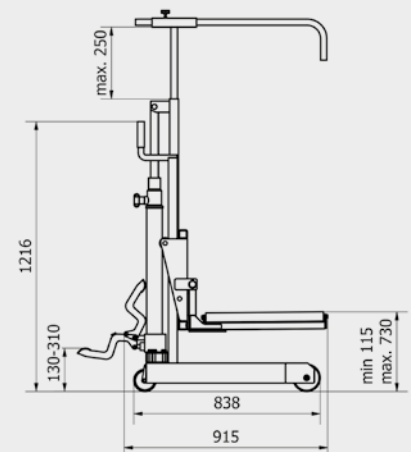
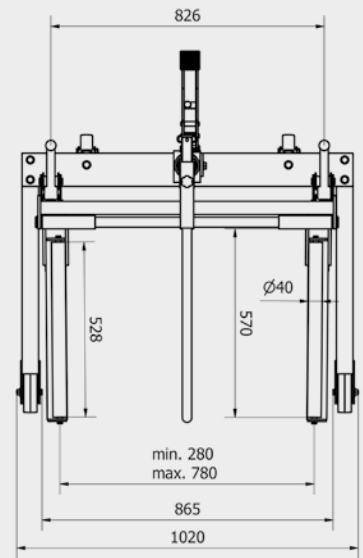



WHEEL LIFTER

AGRICULTURAL AND EARTH MOVING MACHINERY



EASY AND SAFE MOUNTING, DEMOUNTING AND HANDLING OF LARGE WHEELS UP TO 2400 MM





WHEEL LIFTER

AGRICULTURAL AND EARTH MOVING MACHINERY



Capable of handling large wheels from 1250 mm up to 2400 mm in diameter and up to 1050 mm in width.



2 x 4 large rollers improve handling of tyres with deep treads.

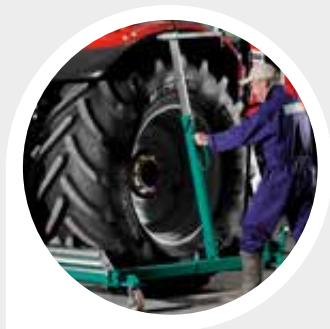

Large open working area, due to the built-in hydraulic.



Hands-free switch between lifting and lowering action.

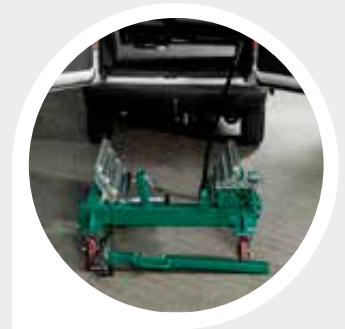

Mobile: Easy to use outside the workshop. Disassembled in a few seconds.



YouTube

Keyword:
Compac WD 1600

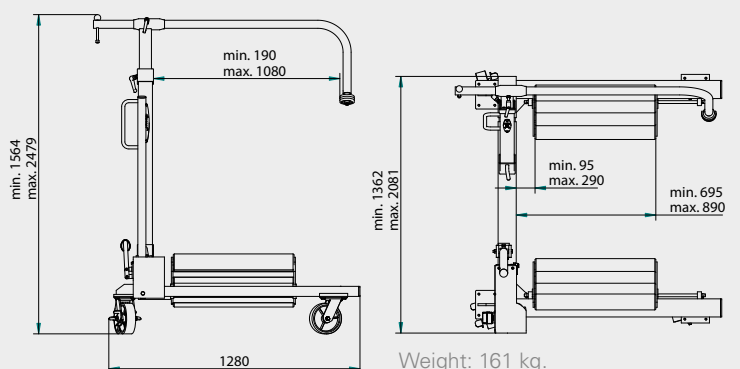



WORKSHOP CRANES CARS



ACCESSORIES



939010
Load sling.
Capacity 500 kg.

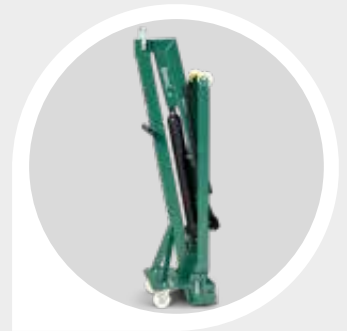

Foldable. Takes up limited space when not in use. (36 x 42 cm)

CC 055 capacity:

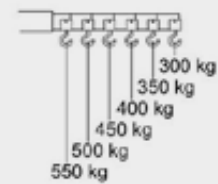

CC 10 capacity:

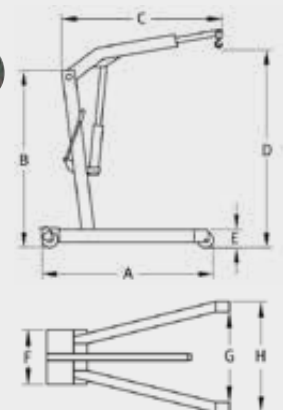
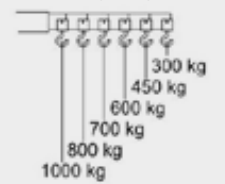

Model	A (mm)	B (mm)	C (mm)	D (mm)	E (mm)	F (mm)	G (mm)	H (mm)	Kg
CC 055	1530	1500	Min. 985 Max. 1435	2120 Max. 550 kg. 2455 Max. 300 kg.	88	440	865	1020	103
CC 10	1530	1500	Min. 985 Max. 1435	2120 Max. 1000 kg. 2455 Max. 300 kg.	88	440	865	1020	103



WORKSHOP CRANES

CARS AND INDUSTRIAL USE



The extra long reach of the lifting arm enables easy lifting of engines on modern cars.

Swivel pump handle position enables easy operation by just one mechanic.



CC 10

Workshop crane with high capacity. Ideal for industrial use.

The industrial workshop crane fits around a standard EUR pallet.



CC 15P

CC 15P capacity:

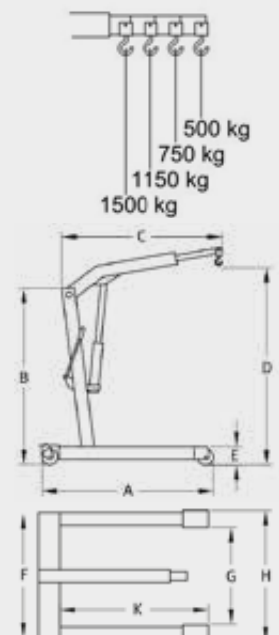

Model	A (mm)	B (mm)	C (mm)	D (mm)	E (mm)	F (mm)	G (mm)	H (mm)	K (mm)	Kg
CC 15P	1720	1860	Min. 1370 Max. 1820	2745 Max. 1500 kg. 3110 Max. 500 kg.	200	1000	850	1015	1570	147



UNIVERSAL TRANSMISSION JACKS CARS AND VANS



Reversible transmission adaptor with saddle and rubber pad.

Ideal for handling and supporting exhaust systems, fuel tanks, etc.

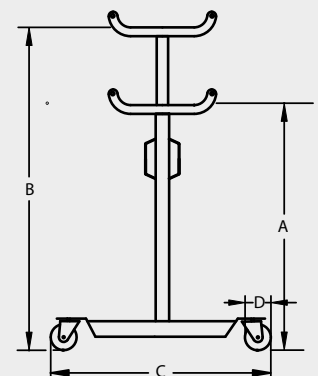
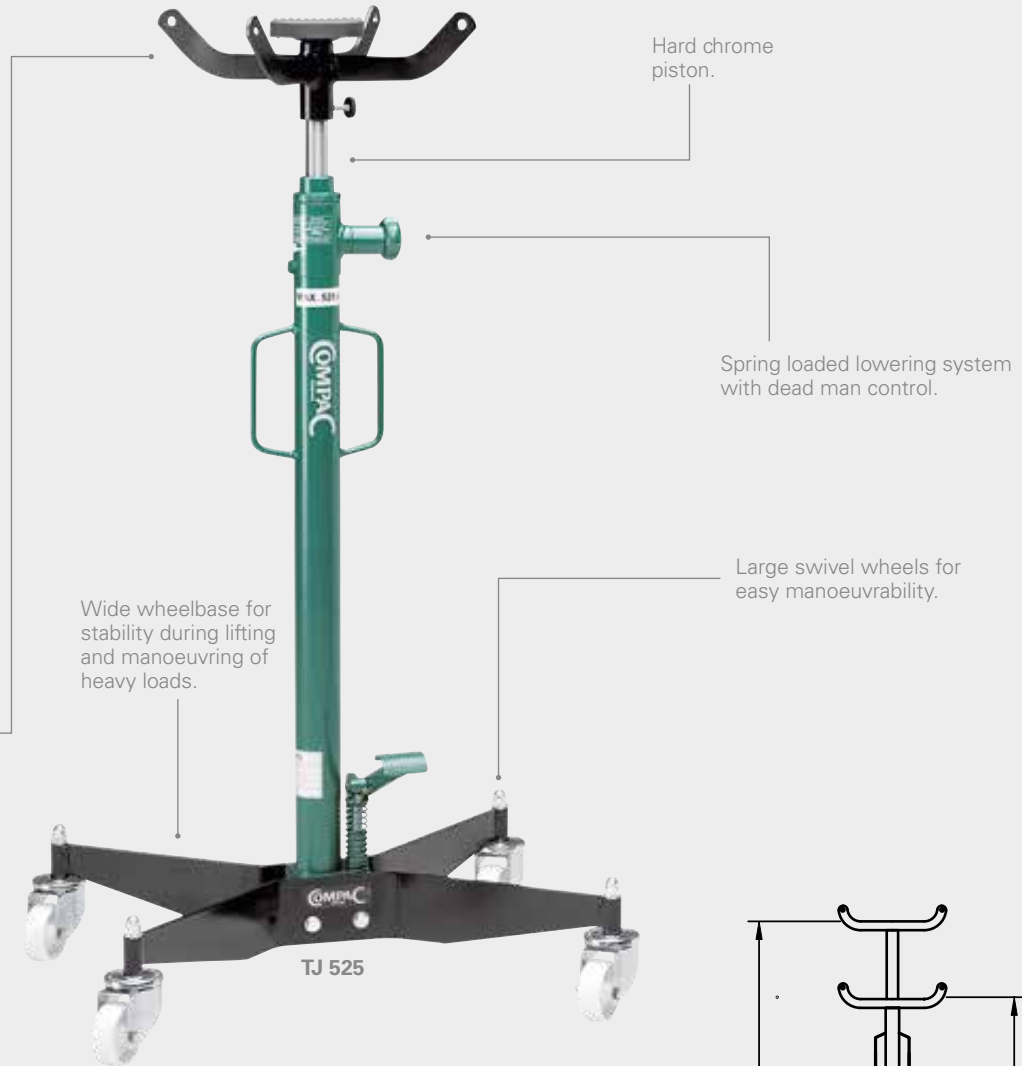

Model	Max (kg)	A (mm)	B (mm)	C (mm)	D (mm)	Kg
TJ 300	300	1095	1930	465 x 565	60	24
TJ 325	325	1170	2020	595 x 535	80	30
TJ 525	525	1170	2020	595 x 535	80	32
TJ 1000	1000	1170	2000	595 x 535	100	38



ACCESSORIES FOR TRANSMISSION JACKS CARS AND VANS



053012/053015



939014

ACCESSORIES



Model	Nr.
TJ 300	053012
TJ 325	053012
TJ 525	053012
TJ 1000	053015
TJ-T 1300	053015

McPherson strut support.
For supporting and holding the suspension strut when working on the wheel suspension.

The McPherson strut support prevents the strut from moving downwards when dismantling the suspension strut from the transverse link.



Model	Nr.
TJ 300	053004
TJ 325	053004
TJ 525	053005
TJ 1000	053006
TJ-T 1300	053006

Fluid drain pan with adapter.
Oil drain pan 18,9 litre. Ideal for fast and easy oil changes.



Model	Nr.
TJ 300	053010
TJ 325	053010
TJ 525	053011
TJ 1000	053013
TJ-T 1300	053013

Adapter.
Adapter without the four arms. Enhances access to areas with limited space.



Model	Nr.
TJ 300	-
TJ 325	-
TJ 525	939014
TJ 1000	939014
TJ-T 1300	939014

Adjustable transmission tool. Tilts in 2 angles to enable positioning and safe handling of transmissions. Capacity 300 kg.

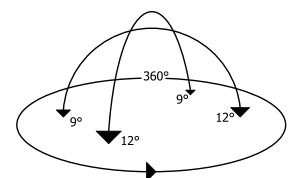



TELESCOPIC TRANSMISSION JACK CARS, VANS AND 4WD



ACCESSORY

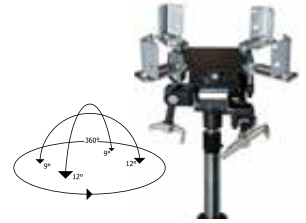

939014
Adjustable transmission tool. Tilts in 2 angles to enable positioning and safe handling of transmissions.

Capacity 300 kg.

939014



Hard chrome pistons.

Ideal for demounting and mounting of engine/transmission.

Two stage cylinder for extra low minimum height and extra long stroke.

Minimum height 1000 mm.

Spring loaded lowering system with dead man control.

Two speed pump unit for fast approach of the piston to working area.

Large swivel wheels for easy manoeuvrability.

Wide wheelbase for stability during lifting and manoeuvring of heavy loads.

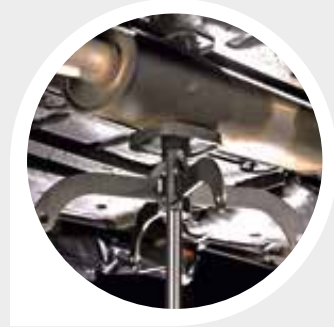

Reversible transmission adaptor with saddle and rubber pad.

Ideal for handling and supporting exhaust systems, fuel tanks, etc.



TJ-T 1300

TJ-T 1300

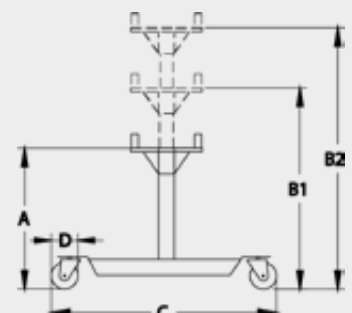

Model	Max (ton)	A (mm)	B1 (mm)	B2 (mm)	C (mm)	D (mm)	Kg
TJ-T 1300	1.3 / 0.5	1000	1500	2010	760 x 640	100	65



TELESCOPIC TRANSMISSION JACK TRUCKS AND BUSES



ACCESSORY

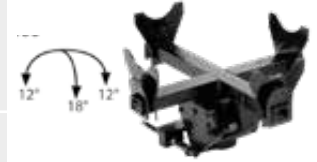

939007
Adjustable transmission tool tilts to enable positioning and safe handling of transmissions.

Capacity 1000 kg.

Triple stage cylinder for extra low minimum height and extra long stroke.

Hard chrome pistons.

Two speed pump unit for fast approach of the piston to working area.

Large swivel wheels for easy manoeuvrability.



TJ-T 2000

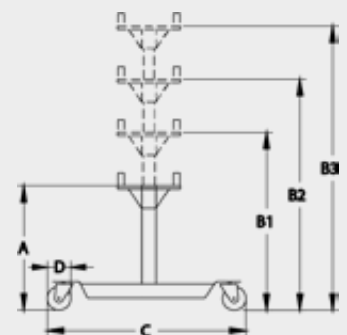

Model	Max (ton)	A (mm)	B1 (mm)	B2 (mm)	B2 (mm)	C (mm)	D (mm)	Kg
TJ-T 2000	2.0 / 1.0 / 1.0	960	1320	1600	1910	1050 x 1050	150	106



SPRING COMPRESSOR CARS



EFFICIENT, PROFESSIONAL AND SAFE DISMOUNTING AND MOUNTING OF MCPHERSON "STRUTS"

Model						
CSC	✓	✓	✓			

Recommended for small and medium size cars.



CSC



YouTube

Keyword:
Compac CSC

STANDARD



2 spring brackets
(Ø78 - 125 mm and Ø125 - 200 mm)

Safety guard.

ACCESSORY



929050
Universal strut vice.



McPherson strut mounted in strut vice.

VEHICLE SPECIFIC SOLUTIONS



929052
Brackets for Mercedes A, B, C and E Class (C-class until 2009).



929059
Bracket for Mercedes C-class from 2010 and later.



929051
929051 Bracket Ø105-182 mm for Renault Megane, Renault Clio, Citroën C3, Citroën C4, Peugeot 208, Peugeot 308, Fiat 500, Toyota Yaris, VW Polo, VW Golf. (Also included in Mercedes kit 929052)



SPRING COMPRESSOR

CARS, EV'S, SUV'S AND VANS



Model						
CSC+	✓	✓	✓	✓	✓	✓

Recommended for small, medium size and large cars. Plus EV vehicles, SUVs and vans.



**You
Tube**

Keyword:
Compac CSC+

60% MORE POWER*



Extra strong arms fitted with Teflon bearings.



Safety guard that also ensures an ergonomic work position.

Hard chrome, solid rods.



Universal swivel jaws that fit „all“ springs. Max. distance between jaws and spring bracket up to 420 mm.

Large Ø160 mm air cylinder for extra compression power.

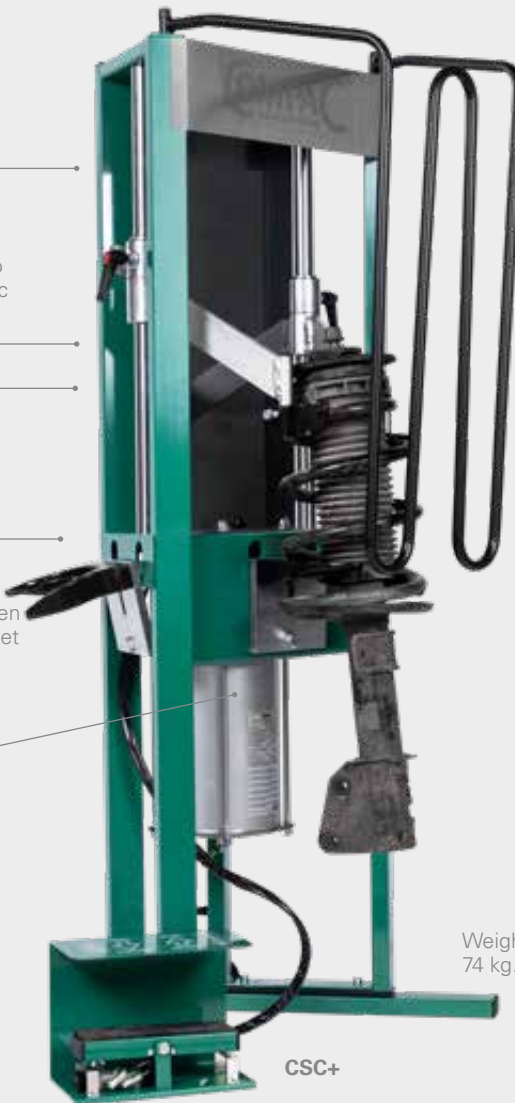

Weight:
74 kg.

CSC+

STANDARD



2 spring brackets
(Ø78 - 125 mm and Ø125 - 200 mm)



Safety guard.

ACCESSORY



929050
Universal strut vice.



McPherson strut mounted in strut vice.



929063
Height adjustable strut support.



929053
Low lip jaws.



929060
Bracket for Renault Koleos, Renault Kadjar, Nissan Qashqai, Nissan Juke.



929057
Strut vise for Chrysler Voyager and Mercedes.



929062
Ideal jaws for coils with an „opposite“ angle. Like left-coils mounted on various Renault and Nissan vehicles.



FOOT OPERATED WORKSHOP PRESSES 16 - 30 TONS CARS, VANS AND SUVs



Moveable cylinder.

ACCESSORY



FP 30: Standard with winch for quick and easy adjustment of table height.

FP 25 with winch: Order model FP 25 W.
FP 20 with winch: Order model FP 20 W.
FP 16 is not available with winch.
Winch can **NOT** be retrofitted!

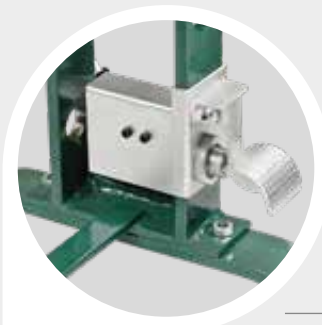

Foot operated air approach feature. (FP 20/FP 25/FP 30)

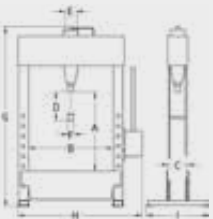

Keyword: Compac FP 30

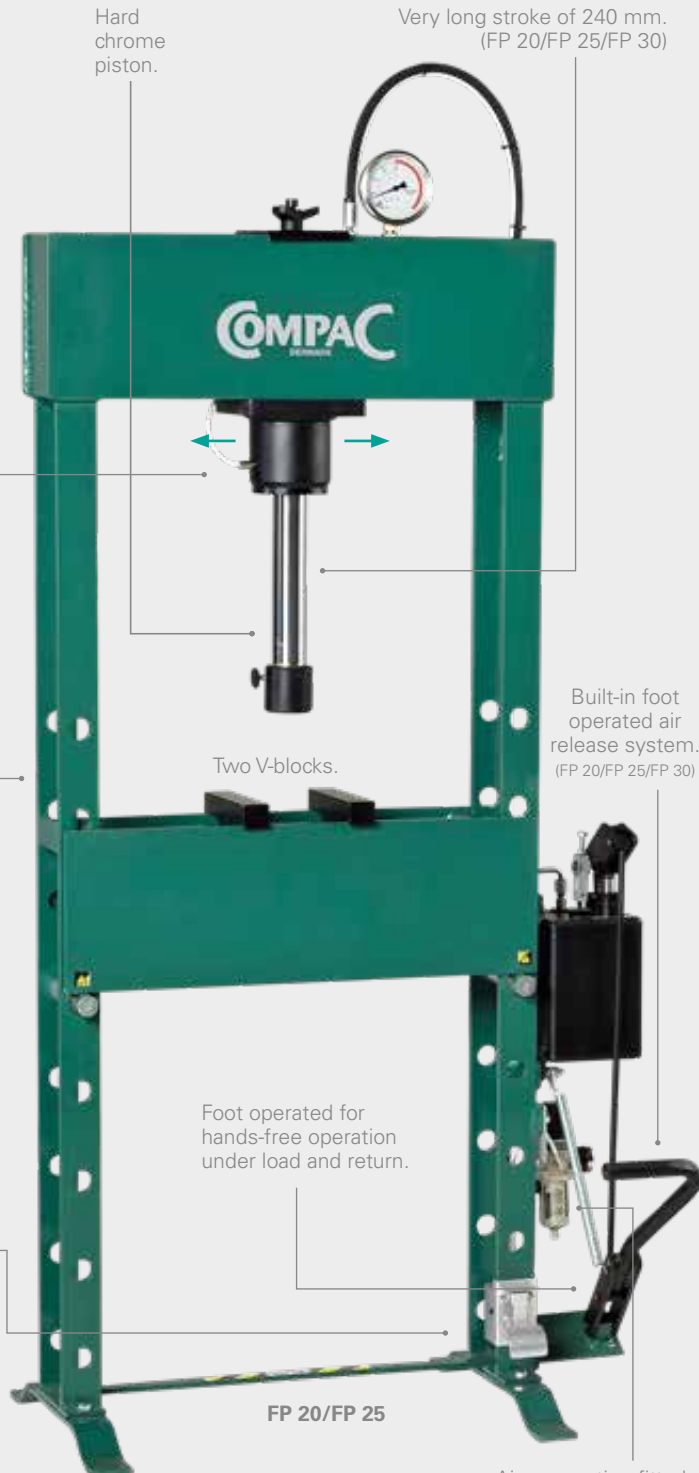

ACCESSORIES



061248
Universal bearing removal support.



061100
Press plate.



061240
Shelves for storing.



Model	Nr.
FP 16	061219
FP 20	061216
FP 25	061216
FP 30	061216

Press punches.

7 pieces, Ø12, 16, 18, 20, 22, 25, 30.



Model	Nr.
FP 16	061220
FP 20	061218
FP 25	061218
FP 30	061218

Bearing removal kit.

4-pieces, Ø 64, 67, 72, 75.



061242
Protection guard.

Air connection fitted with water separator. (FP 20/FP 25/FP 30)

Model	Max (ton)	(mm/stroke)	A (mm)	B (mm)	C (mm)	D (mm)	E (mm)	F (mm)	G (mm)	H (mm)	I (mm)	Kg
FP 16	16	6,0/2,0	1200	550	140	150	65	40	1780	850	600	121
FP 20	20	9,0/1,1	825	600	140	240	90	70	1800	890	505	157
FP 25	25	9,0/1,1	825	600	140	240	90	70	1800	890	505	157
FP 30	30	9,0/1,1	825	600	140	240	90	70	1800	890	505	160



HAND OPERATED WORKSHOP PRESSES 20 - 30 TONS CARS, VANS AND SUVs



Moveable cylinder.

ACCESSORY



HP 30: Standard with winch for quick and easy adjustment of table height.

HP 25 with winch: Order model HP 25 W.
HP 20 with winch: Order model HP 20 W.
HP 16 is not available with winch.
Winch can **NOT** be retrofitted!

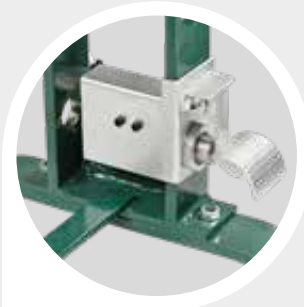

Foot operated air approach feature.

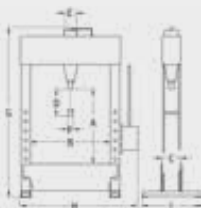

Hard chrome piston.

Very long stroke of 240 mm.

Built-in air release system in handle.



Two V-blocks.

HP 20/HP 25

Air connection fitted with water separator.

ACCESSORIES



061248
Universal bearing removal support.



061100.
Press plate.



061240
Shelves for storing.



Model	Nr.
HP 20	061216
HP 25	061216
HP 30	061216

Press punches.
7 pieces, Ø12, 16, 18, 20, 22, 25, 30.



Model	Nr.
HP 20	061218
HP 25	061218
HP 30	061218

Bearing removal kit.
4-pieces, Ø 64, 67, 72, 75.



061242
Protection guard.

Model	Max (ton)	(mm/stroke)	A (mm)	B (mm)	C (mm)	D (mm)	E (mm)	F (mm)	G (mm)	H (mm)	I (mm)	Kg
HP 20	20	9,0/4,0	825	600	140	240	90	70	1800	890	505	156
HP 25	25	9,0/4,0	825	600	140	240	90	70	1800	890	505	156
HP 30	25	9,0/4,0	825	600	140	240	90	70	1800	890	505	159



FOOT OPERATED WORKSHOP PRESSES 40 - 50 TONS VANS, TRUCKS AND BUSES



ACCESSORIES



061248
Universal bearing
removal support.

Model	Nr.
FP 40	061248
FP 50	061248



Fast and safe
adjustment of the press table
height, using a braked winch.



Foot operated air approach
feature.

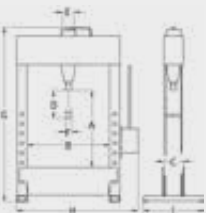

FP 50

Air connection
fitted with water
separator.

Foot operated for
hands-free operation.



YouTube Keyword:
Compac FP 50

ACCESSORIES



061100
Press plate.



061240
Shelves for
storing.



Model	Nr.
FP 40	061216
FP 50	061216

Press punches.
7 pieces, Ø12, 16, 18, 20,
22, 25, 30.



Model	Nr.
FP 40	061218
FP 50	061218

Bearing removal kit.
4 pieces, Ø 64, 67, 72, 75.



Model	Nr.
FP 40	061243
FP 50	061243

Protection guard.

Model	Max (ton)	(mm/ stroke)	A (mm)	B (mm)	C (mm)	D (mm)	E (mm)	F (mm)	G (mm)	H (mm)	I (mm)	Kg
FP 40	40	6,0/0,8	750	840	200	300	125	70	1990	1350	630	375
FP 50	50	6,0/0,8	750	840	200	300	125	70	1990	1350	630	375



HAND OPERATED WORKSHOP PRESSES 40 - 100 TONS VANS, TRUCKS AND BUSES



ACCESSORIES



061248
Universal bearing
removal support.

Model	Nr.
HP 40	061248
HP 50	061248
HP 60	-
HP 70	-
HP 100	-



Fast and safe
adjustment of the press table
height, using a braked winch.



Foot operated air approach
feature.



ACCESSORIES



061100
Press plate.



061240
Shelves for
storing.



Model	Nr.
HP 40	061216
HP 50	061216
HP 60	061228
HP 70	061228
HP 100	061233

Press punches.
7 pieces, Ø12, 16, 18, 20,
22, 25, 30.



Model	Nr.
HP 40	061218
HP 50	061218
HP 60	061229
HP 70	061229
HP 100	061234

Bearing removal kit.
4 pieces, Ø 64, 67, 72, 75.



Model	Nr.
HP 40	061243
HP 50	061243
HP 60	061245
HP 70	061245
HP 100	061247

Protection guard.

Model	Max (ton)	(mm/stroke)	A (mm)	B (mm)	C (mm)	D (mm)	E (mm)	F (mm)	G (mm)	H (mm)	I (mm)	Kg
HP 40	40	6,0/1,5	750	840	200	300	125	70	1990	1350	630	374
HP 50	50	6,0/1,5	750	840	200	300	125	70	1990	1350	630	374
HP 60	60	5,0/0,8	760	1005	255	300	160	80	2100	1615	710	690
HP 70	70	5,0/0,8	760	1005	255	300	160	80	2100	1615	710	690
HP 100	100	3,4/0,8	915	1035	305	300	200	100	2200	1637	800	946



ELECTRO-HYDRAULIC WORKSHOP PRESSES 40 - 60 TON WITH SINGLE ACTING CYLINDER



ACCESSORIES



061248
Universal bearing
removal support.

Model	Nr.
EP 40	061248
EP 60	-



Fast and safe
adjustment of the press table
height, using a braked winch.



A 90° hinged pump unit
enables easier insertion
of longer work-pieces.

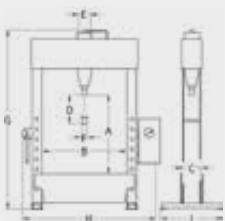

Single acting cylinder:
One-way pressing action for where heavy
tooling is not to be mounted on the piston.



ACCESSORIES



061100
Press plate.



061240
Shelves for
storing.



Model	Nr.
EP 40	061216
EP 60	061228

Press punches.
7 pieces, Ø12, 16, 18, 20,
22, 25, 30.



Model	Nr.
EP 40	061218
EP 60	061229

Bearing removal kit.
4 pieces, Ø 64, 67, 72, 75.



Model	Nr.
EP 40	061243
EP 60	061245

Protection guard.

Model	Max (ton)	(mm/ stroke)	A (mm)	B (mm)	C (mm)	D (mm)	E (mm)	F (mm)	G (mm)	H (mm)	I (mm)	Kg	Kw
EP 40	40	10,0	750	840	200	300	125	70	1990	1480	630	390	2,2
EP 60	60	10,0/5,0	760	1000	255	300	160	80	2100	1680	710	694	2,2



ELECTRO-HYDRAULIC WORKSHOP PRESSES 40 - 100 TON WITH DOUBLE ACTING CYLINDER



ACCESSORIES



061248
Universal bearing
removal support.

Model	Nr.
EP 40 D	061248
EP 60 D	-
EP 100 D	-



Fast and safe
adjustment of the press table
height, using a braked winch.



A 90° hinged pump unit
enables easier insertion
of longer work-pieces.



Double acting cylinder:
Hydraulic pressing and pulling action. Ideal when heavy
tooling is mounted on the piston.



EP 40 D

Multi-adjustable
pressure valve.



Model	Max (ton)	(mm/stroke)	A (mm)	B (mm)	C (mm)	D (mm)	E (mm)	F (mm)	G (mm)	H (mm)	I (mm)	Kg	Kw
EP 40 D	40	10,0	750	840	200	300	125	70	1990	1480	630	396	2,2
EP 60 D	60	10,0/5,0	760	1000	255	300	160	80	2100	1680	710	702	2,2
EP 100 D	100	10,0/1,4	915	1035	305	300	200	100	2200	1780	800	981	2,2

ACCESSORIES



061100
Press plate.

061240
Shelves for
storing.



Model	Nr.
EP 40 D	061216
EP 60 D	061228
EP 100 D	061233

Press punches.
7 pieces, Ø12, 16, 18, 20,
22, 25, 30.



Model	Nr.
EP 40 D	061218
EP 60 D	061229
EP 100 D	061234

Bearing removal kit.
4 pieces, Ø 64, 67, 72, 75.



Model	Nr.
EP 40 D	061243
EP 60 D	061245
EP 100 D	061247

Protection guard.



BOTTLE JACKS 3 - 50 TON



SHARK&CO.

BOTTLE JACKS

- Screw type extension (3-20 tons)
- Fitted with carry handle (10-50 tons)
- Built-in safety overload valve.

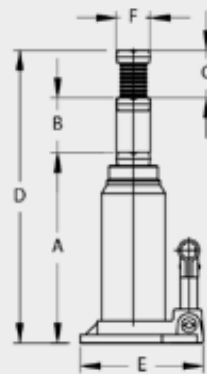

Model	Max (ton)	A (mm)	B (mm)	C (mm)	D (mm)	E (mm)	F (mm)	Kg
CBJ 3	3	193	120	60	373	110x103	26	3
CBJ 5	5	210	136	70	416	122x115	30	3,9
CBJ 10	10	230	150	80	460	132x120	36	5,6
CBJ 15	15	230	150	60	440	144x134	43	7,2
CBJ 20	20	242	150	60	452	159x143	46	9,2
CBJ 30	30	275	165	-	440	169x153	49	11,9
CBJ 50	50	265	160	-	425	210x176	83	25,8
CBJ-T 10	10	215	247	78	540	150x145	37	9,3

Compac reserves the right to discontinue products, change prices and to supply products that may differ from the illustrations and specifications.

Compac Hydraulik A/S

Strandhusevej 43 // 7130 Juelsminde // Denmark // Tel: +45 75 69 37 22 // info@compac.dk
www.compac.dk